



U SERIES

U3 U6 | U3 H.E.A.T. U6 H.E.A.T.

High Precision Sinker EDM



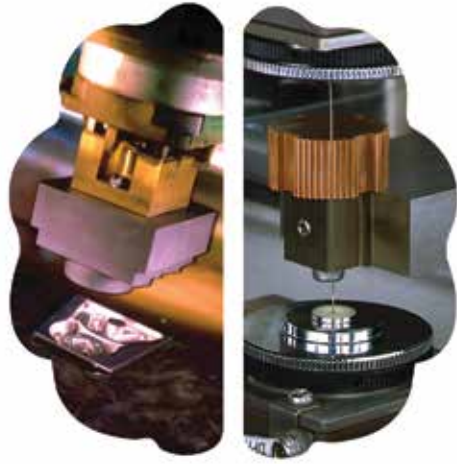

Hyper

TECHNOLOGIES

Makino's family of Hyper Technologies revolutionize the machining process in both Sinker and Wire EDM, and ensures the ideal mix of Speed, Finish, Reduced Electrode Wear or Reduced Trim Cuts, to achieve the ultimate in productivity!

The unified Hyper-i Control delivers an identical streamlined interface to both Wire and Sinker EDM operations, and provides new levels of capability, efficiency, and user friendliness.

Hyper *i*

New Generation - Touch screen controller available for both Sinker and Wire EDM that makes machining easy as Ready, Set , Go!



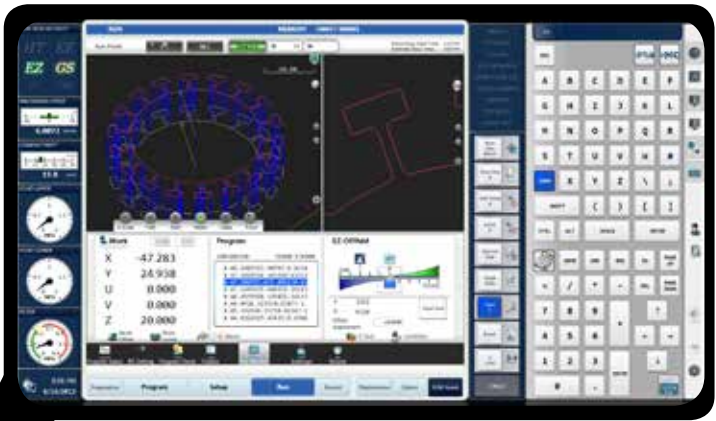

The Hyper-i Control improves machine productivity by intelligently streamlining the interface so that all operator skill levels can achieve the most efficient results.

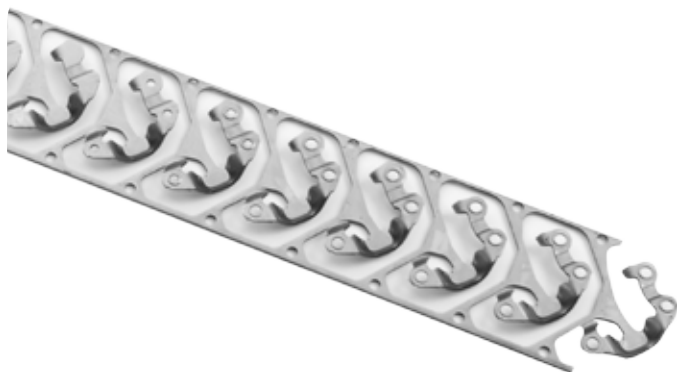

Pressed Part



Pressed Part



Punch



400mm Plate Thickness

U3 U3 H.E.A.T.



Compact design

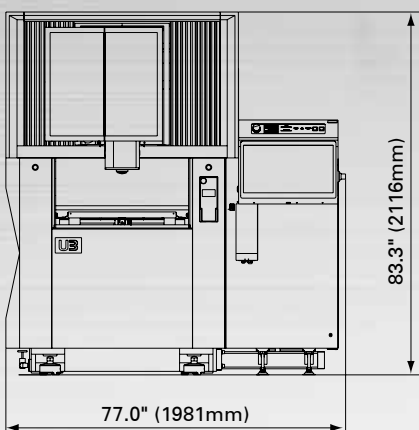

U3 / U3 H.E.A.T.

Axis Travels (X/Y/Z)	14.56" x 10.63" x 8.66" (370 x 270 x 220mm)
Axis Travels (U/V)	±1.96" (±50mm)
Max Work Size	30.32" x 23.23" x 8.66" (770 x 590 x 220mm)
Max Fluid Height	10.24" (260mm)
Max Work Weight	1,322 lbs. (600 kg)
Height to Table Surface	37.40" (950mm)
Machine Weight	7,054 lbs. / 7,275 lbs. (3200 / 3300 kg)
Wire Diameter	0.004", 0.006", 0.008", 0.010", 0.012" (0.10, 0.15, 0.20, 0.25, 0.30mm)

U6 U6 H.E.A.T.



*Additional 2nd screen, keyboard and mouse are optional

Compact design

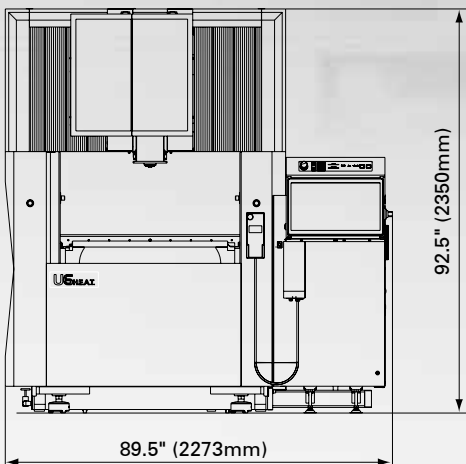

U6 / U6 H.E.A.T.

Axis Travels (X/Y/Z)	25.59" x 17.71" x 16.53" (650 x 450 x 420mm)
Axis Travels (U/V)	±2.95" (±75mm)
Max Work Size	39.37" x 31.50" x 15.75" (1000 x 800 x 400mm)
Max Fluid Height	17.91" (455mm)
Max Work Weight	3,306 lbs. (1500 kg)
Height to Table Surface	39.37" (1000mm)
Machine Weight	11,464 lbs. / 11,684 lbs. (5200 / 5300 kg)
Wire Diameter	0.004", 0.006", 0.008", 0.010", 0.012" (0.10, 0.15, 0.20, 0.25, 0.30mm)

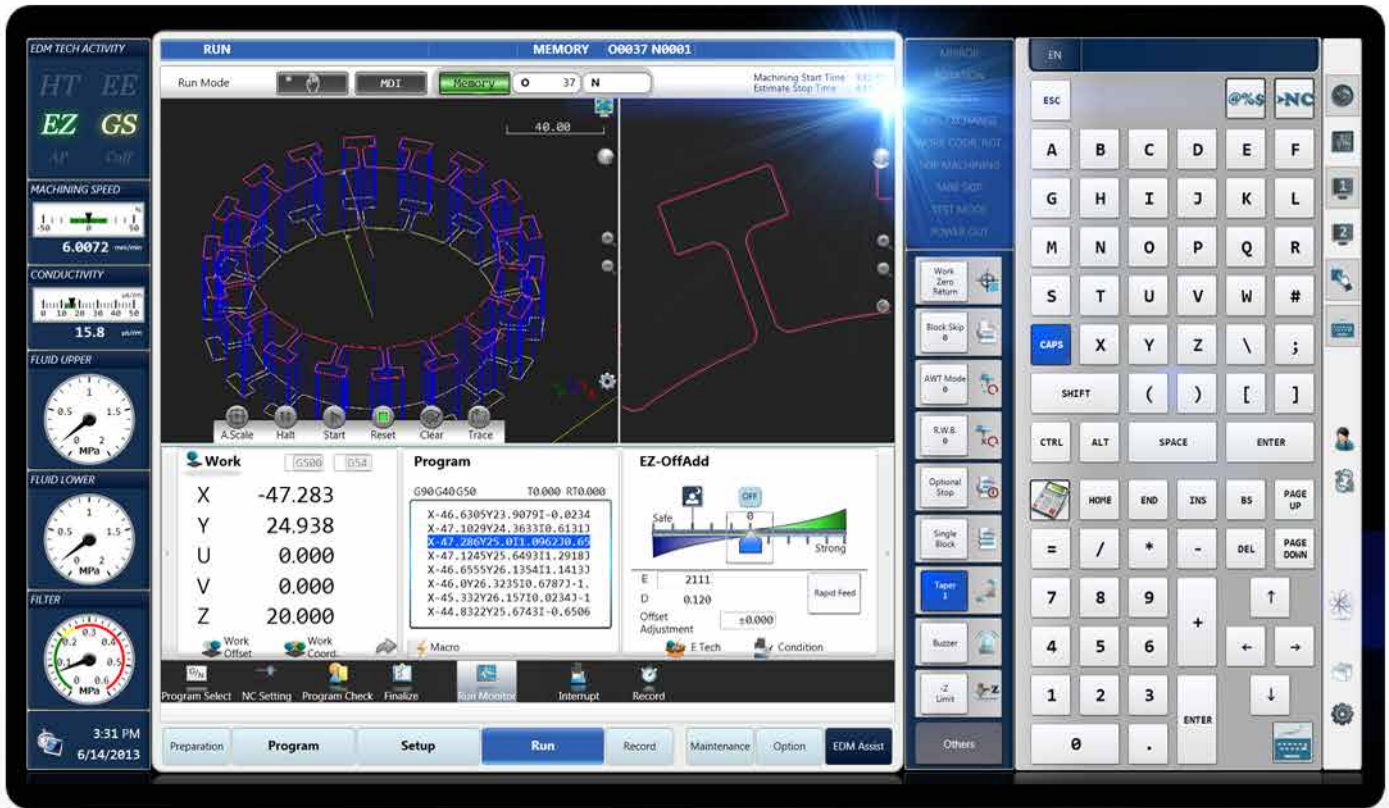

*i*ntuitive | *i*ntelligent | *i*nteractive

Makino's new Hyper-i Control revolutionizes the interface between the operator and the machine. Using the most current interface technologies used by SmartPhones and Tablets, Makino's Hyper-i Control makes use of Pinch, Swipe and Spread functions that provide the operator with a simple and natural feel that is comfortable and extremely efficient. The user friendliness of the Hyper-i Control is further enhanced with the integration of on-board digital manuals, intelligent help functions, and e-Learning training system.

Any operator with a basic knowledge of machining can learn Makino's Hyper-i Control. Operators quickly learn and appreciate the technology and power that the Hyper-i Control provides, and most operators are able to produce sophisticated part details on the first day of installation. Hyper-i brings a completely new level of user-friendliness, operator comfort, and efficiency to the shop floor.

1. Program

2. Setup

3. Run

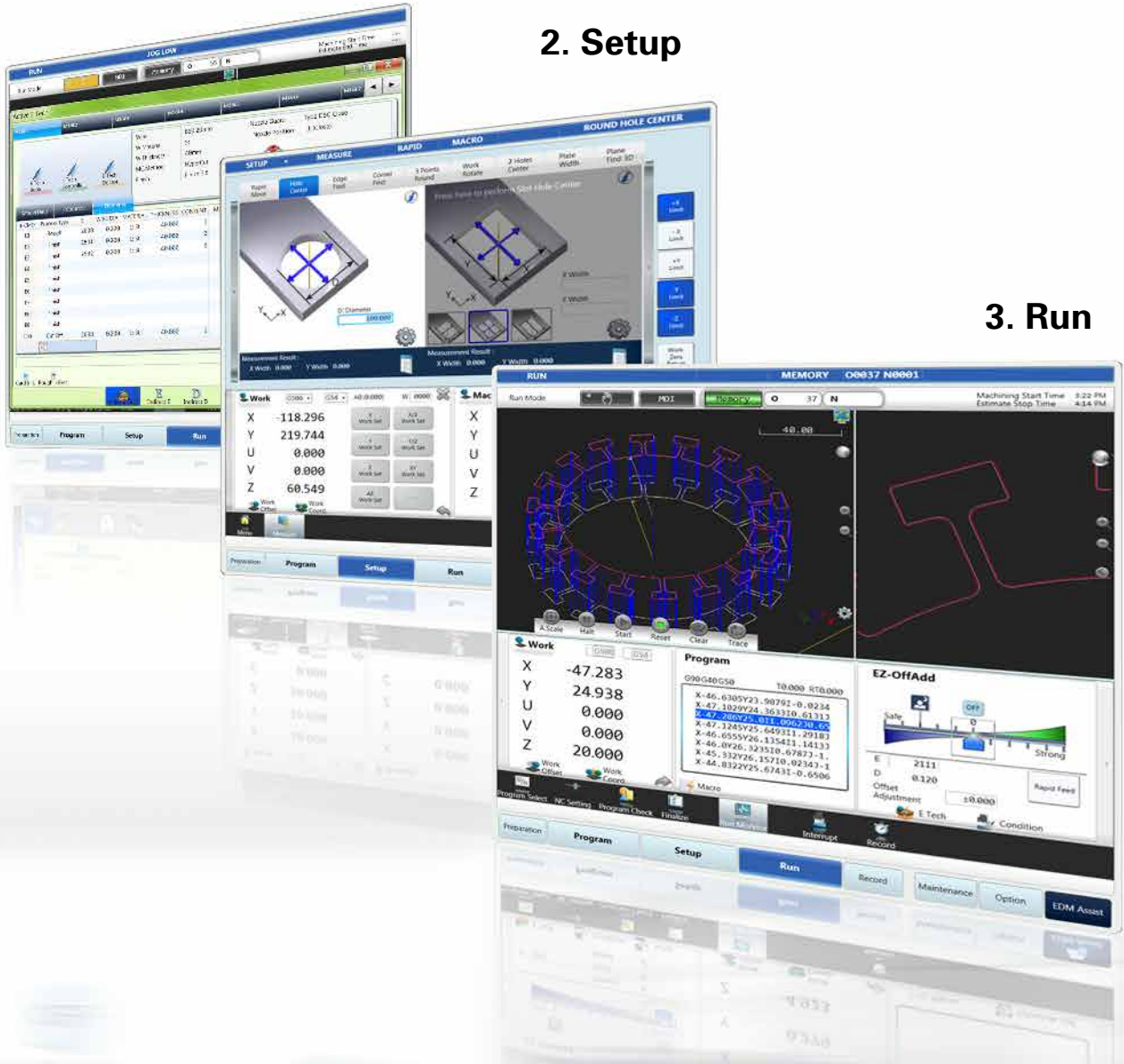

Gesture Control is the natural way to interact with the machine

PINCH

TOUCH

SWIPE

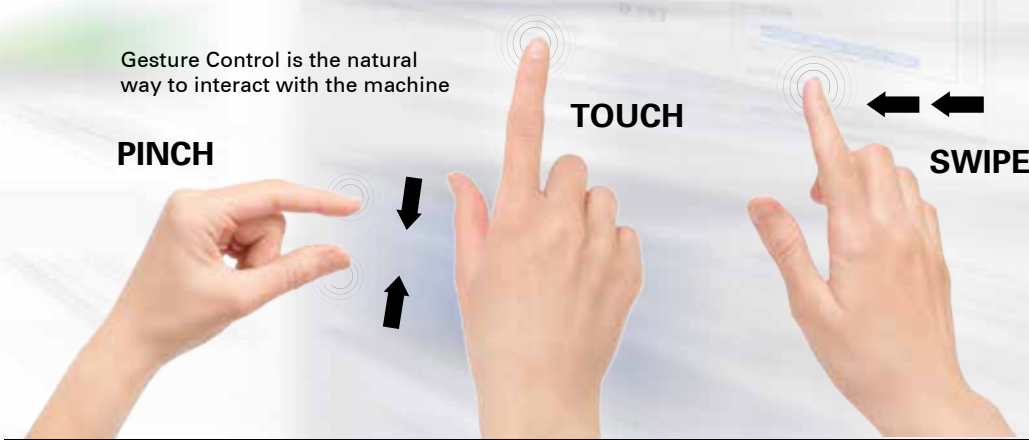

Setup Function

Provides the operator with an easy and streamlined method for aligning the wire to the work piece. There are multiple standard Pick-Up cycles that help reduce setup time

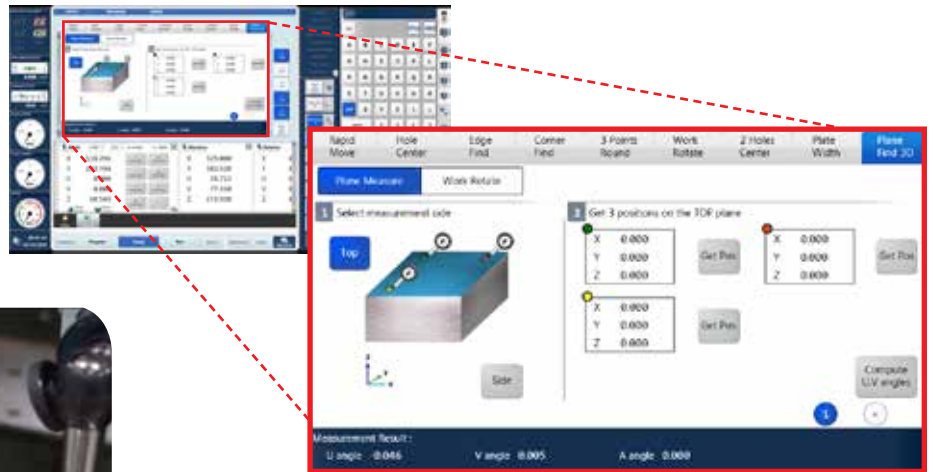
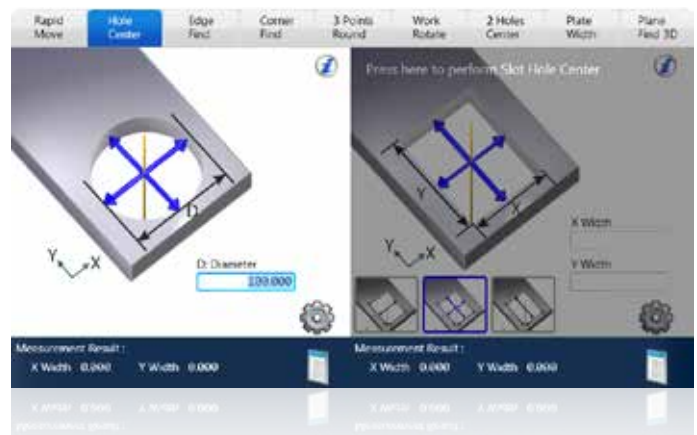

3D Plane Find Function

Save valuable time by eliminating the need for manual part leveling of the work piece using the 3D Plane Find function. The function is used to capture and record 3 points using a Dial Test Indicator and then calculates and aligns the U/V axes plane so that it is skewed to be perpendicular with the work piece.

E-Tech Doctor

The E-Tech Doctor is an advanced intelligent help function that provides a method of adjusting machining conditions to achieve your perfect part! The revolutionary interface combines the knowledge and experience of an advanced operator into a easy to use graphical menu.

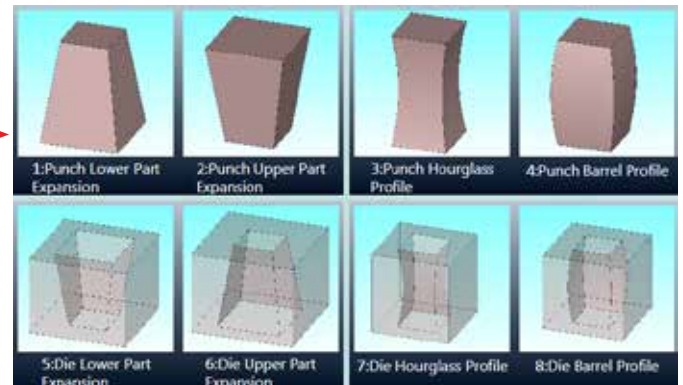
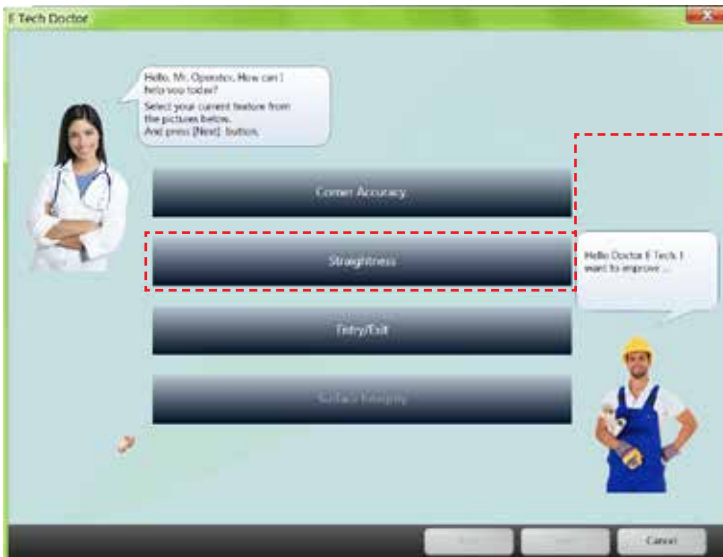

Supportive Tools

The many additional functions incorporated into the Hyper i control are designed to improve user-friendliness and productivity. An Estimate function provides Cycle Time and Cost estimates while also monitoring the condition of consumables items. A Record page tracks and reports on machine utilization, which provides a valuable tool in identifying areas for operational improvements.

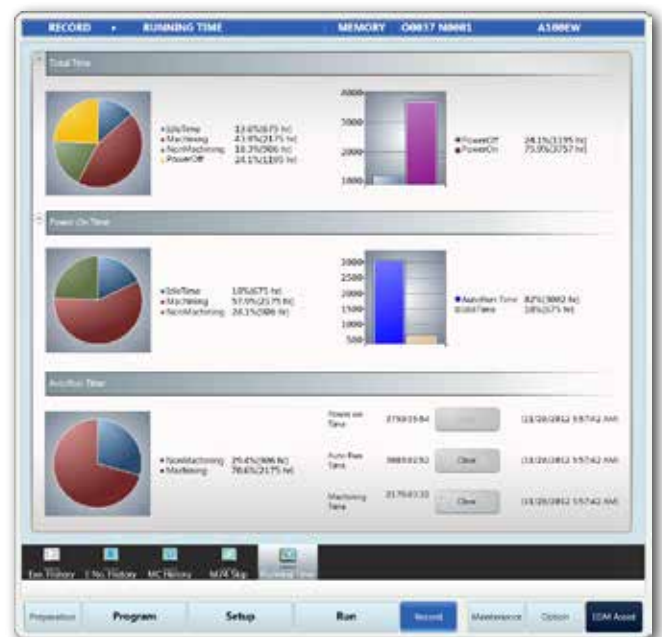

EZ-Cut Function

The EZ-Cut slider bar provides both novice and experienced operators with a convenient tool to raise or lower the machining speed using a simple slide bar interface. This function will automatically adjust several power setting elements in real-time, and is effective in reducing cycle time or improving process stability.

EZ-OffAdd

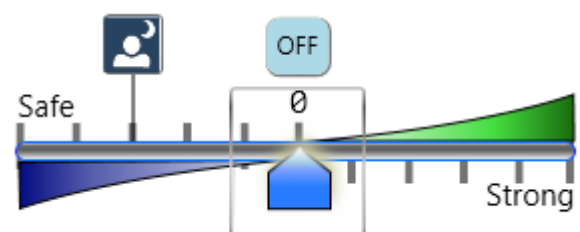

SOLUTIONS FOR EVERY INDUSTRY

The Makino U Series will provide a Universal approach to a wide range of applications sure to address the most demanding needs of Die/Mold, Job Shop, and Production Machining industries.

Medical Guide Plate



Medical Surgical Instrument: Guide Plate

- ▶ 420 Stainless Steel, 50mm thick
- ▶ H.E.A.T. improves the productivity of Index & Burn operations
- ▶ Cost efficient manufacturing with (3) parts stack process
- ▶ Rotary table used to machine multiple parts and part details in a single setup



Medical Implant: Staple Production

- ▶ Titanium Alloy - 6Al4V, 9mm thick
- ▶ Parts Production using dia. 0.100mm Brass Wire and a rotary table
- ▶ Minimal recast layer and without any "bluing" effect
- ▶ Machining time: 5min 30 sec per part (when machining 40 parts)

Stamping Die Punch

- ▶ Tool Steel, 100mm thick
- ▶ Hyper-Cut Technology achieves a superior surface finish of $3,5 \mu\text{m}$ ($0.42 \mu\text{m Ra}$) in just 3 cuts
- ▶ Straightness: $2 \mu\text{m}$ (one side)



Stamping Die Punch

- ▶ Carbide (G3), 100mm thick
- ▶ To address all requirements a wide range of machining conditions are available as standard fine surface finish of $1 \mu\text{m Rz}$ ($0.14 \mu\text{m Ra}$) is achieved in just 5 cuts



Stamping Die Plate

- ▶ Tool Steel, 20mm thick
- ▶ Makino Pico guides cut small micro tapers with the highest possible accuracies and ensure successful wire threading into small holes.



Production of Gear

- ▶ 420 Stainless Steel, 50mm thick
- ▶ H.E.A.T. Technology provide outstanding high-speed machining of $128 \text{ mm}^2/\text{min}$ in the most difficult flushing conditions with nozzles detached from the work piece.
- ▶ Surface finish down to $4.8 \mu\text{m Rz}$ ($0.6 \mu\text{m Ra}$) is achieved in just 3 passes



Plastic injection cavity for car dashboard

- ▶ Tool Steel, 200mm thick
- ▶ Fast and accurate machining is realized even with work pieces containing complex thickness transitions
- ▶ Eliminate post-process hand polishing



Power Generation Insert

- ▶ Inconel - high nickel alloy, 150mm thick
- ▶ H.E.A.T. technology provide high speed machining in the most difficult flushing conditions using 0.3mm wire hard brass



Aerospace Hinge

- ▶ Titanium Alloy - 6Al4V, 120mm thick
- ▶ Wire Type: 0.300mm hard brass
- ▶ Achievable straightness to $5 \mu\text{m}$ in just one pass
- ▶ High tolerance metallurgical integrity and less recast layer



Medical Surgical Tool

- ▶ Tool Steel (2.3mm Dia.)
- ▶ Machine extremely fine details with wire dia. 0.1 mm and Wire EDM turning at 800rpm



HyperCut

HyperCut Technology addresses the demanding need to deliver a superior surface finish while reducing trim cuts.

HyperCut was specifically developed for the precision stamping die building industry.

Competitive results are achieved in a wide range of applications using different wire type, wire size diameters, workpiece thickness and materials.

3 μmRz /3 Pass Machining on Steel



Analysis - R/5x0.8mm/G/300/LS Line

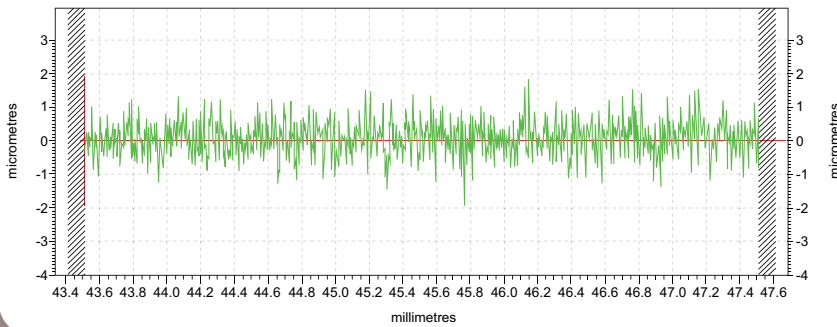

Workpiece Material: Steel (SKD-11)
 Wire Used: 0.25mm dia. brass wire
 Material Thickness: 80mm
 Surface Finish: 3 μmRz (0.4 μmRa)

Surface finish down to 2.5 μmRz (0.34 μmRa) can be realized as well using only 4 Pass Machining (steel, 80mm thick).



Superior surface finishing even in the tallest workpiece applications

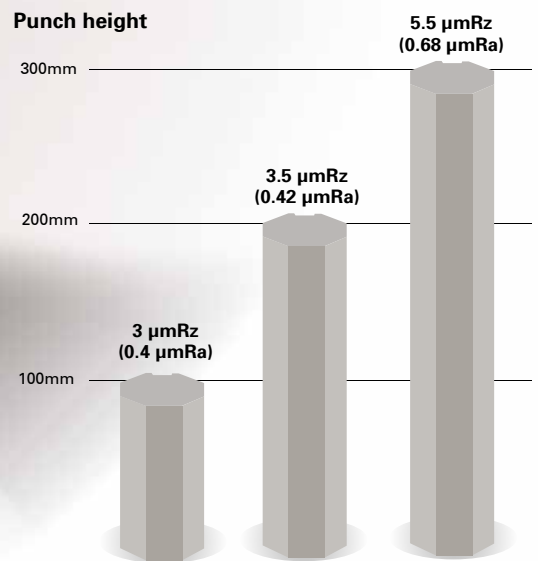

Surface finishing with just 3 cuts machining: Steel



2,5 μmRz /3 Pass Machining on Carbide (G3)

Material Thickness: 100mm



Cut fast with less wire

Comparison of machining time with surface finish is 3 μmRz (Ra0.4 μm)

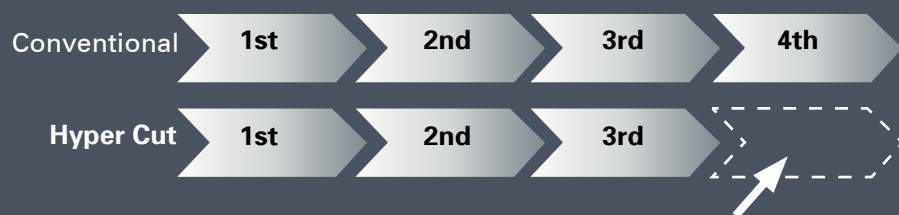

The elimination of the 4th Skim Cut provides a **20%** reduction of cycle time and an additional **14%** reduction in wire consumption.

Hyper-Cut address the most demanding needs of every Industry

Aerospace – Fir Tree

410 Stainless Steel, 38mm thick
 Machining Time: 1 hr 17min
 Surface Finish: 3 μmRz (0.4 μmRa)

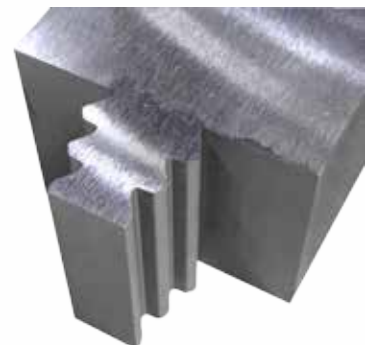

H.E.A.T. (HIGH ENERGY APPLIED TECHNOLOGY)

Fastest both nozzle away machining in the world

In EDM, the most difficult cuts are when the nozzles are detached from the workpiece. Makino H.E.A.T. Technology uses a combination of flushing enhancements and special generator upgrades that greatly increase cutting speed. As a result, Makino H.E.A.T. Technology delivers a part to the customer with minimal operator intervention, fast, accurate and with superior surface finishes. This combination is unmatched in the EDM industry.

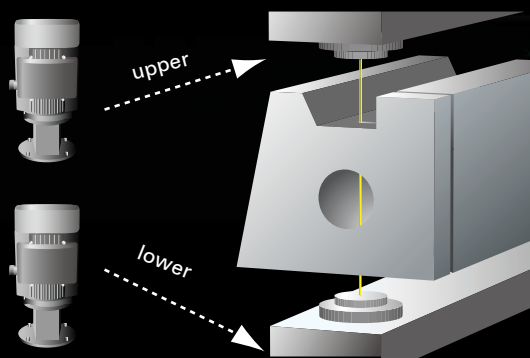

H.E.A.T. Technologies unique flushing capability is a result of our High Capacity Digitally Controlled Dual Flushing pumps.



Workpiece Material : S55C (steel)
Wire Used : Dia. 0.25 mm brass wire
Plate Thickness: 150 mm
No. of Passes: 1
Machining Nozzle Position: Top and bottom separated by 8 mm
Machining Length: 353.8 mm

Straightness improved by **58%**
12 μm \rightarrow 5 μm on one side

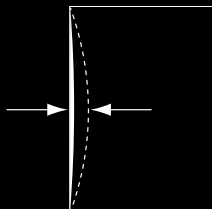

Machining speeds improved by **75%**
49.5 mm^2 / min \rightarrow 87.0 mm^2 / min

Machining time reduced by **43%**
17 hr. 52 min. \rightarrow 10 hr. 10 min



Plastic injection cavity
for car dashboard



Die cast insert
(outside cut profile WEDM)



Mechanical
component



Medical instrument

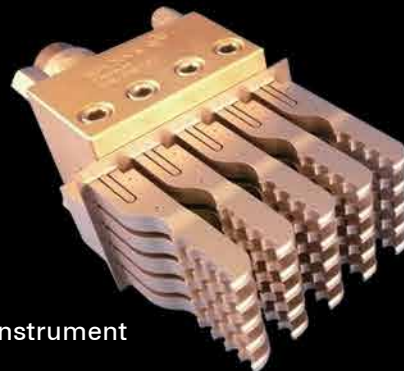

H.E.A.T. 3 pass machining

Surfaces finishes down to Rz 5 μ m can be achieved using just three passes using H.E.A.T. Technology.

Workpiece Material:	STAVAX (stainless steel)
Wire Used:	Dia. 0.25 mm (BS)
Plate Thickness:	60~100 mm
No. of Machining Passes:	3
Machining Speed:	1st 1.9-1.3 mm / min 2nd 7.8 mm / min 3rd 8 mm / min
Surface Finish:	Rz 5 μ m (Ra 0.68 μ m)



T.G. CONTROL (SurfaceWIZARD)

T.G. Control (SurfaceWIZARD) produces unmatched surface quality that is free from wire gouge lines and dimensional errors caused by uneven or stepped work pieces. The high quality and high precision results, once thought as near impossible to achieve, can eliminate the need for post-process hand polishing.

Dimensional difference
(Actual value μm /one side)

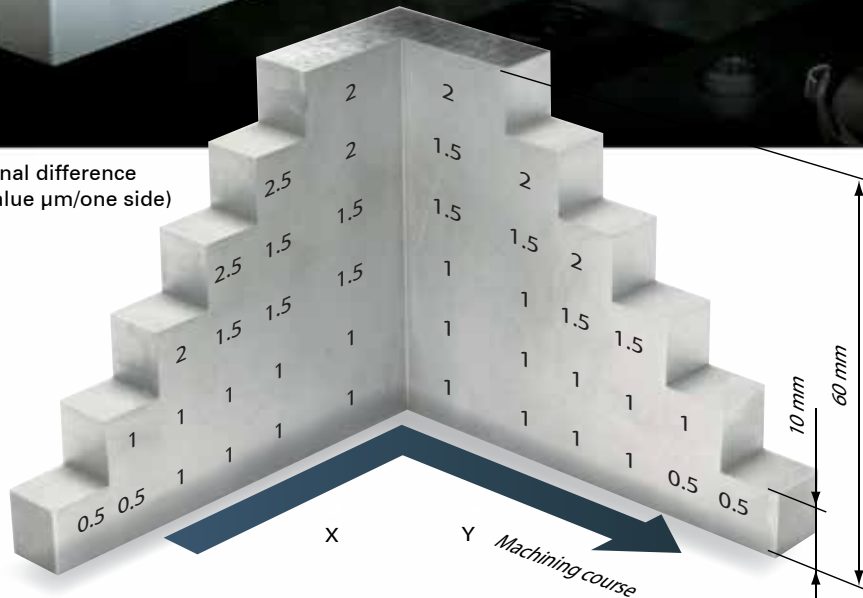

Workpiece material	: SKD-11(steel)
Wire used	: Dia. 0.2mm(BS)
Plate thickness	: 10-60mm
No. of machining passes	: 2
Surface finish	: Rz 10 μm (Ra 1.4 μm)

There are a wide range of material thickness variation conditions with available second and third machining pass settings. Compatible wire diameters: Dia. 0.200, 0.250, and 0.300mm

No difference in part straightness and surface finishes even in opposite machining directions.

- Machining from the higher to lower levels of a workpiece.
- Machining from the lower to higher levels of a workpiece.
- Machining in different axis directions, such as X and Y.

Machining Conditions:

- ▶ 5 ~ 20mm plate thickness
- ▶ 10 ~ 60mm plate thickness
- ▶ 40 ~ 100mm plate thickness
- ▶ 80 ~ 150mm plate thickness

Surface finishes down to Rz 4 μm (Ra 0.5 μm) can be realized using only 3 Pass Machining.

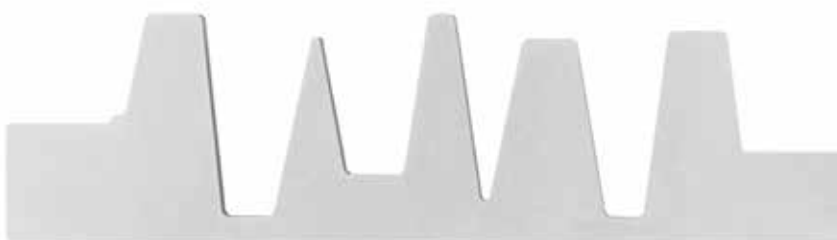

Extrusion dies with TG-Control

GS-Cut (BellyWIZARD)

Incredible straightness

Makino's proven technology **GS-Cut (Belly Wizard)** incorporates a unique approach to part straightness in the tallest workpiece applications. Achieving tolerances of $5\ \mu\text{m}$ over 300mm are realized using only one cut using Makino's Belly Wizard Technology.

This efficiency-enhancing technology produces a straighter and more accurate work piece during the rough cut while also reducing wire consumption. From this improved precision, finishing passes are also faster and more accurate by having to remove less material and error from the final work piece.



Workpiece Material : steel
 Wire Used : Dia. 0.3 mm (BS)
 Plate Thickness : 400 mm
 No. of Machining Passes : 1
 Surface Finish : Rz 22 μm (Ra 3.8 μm)

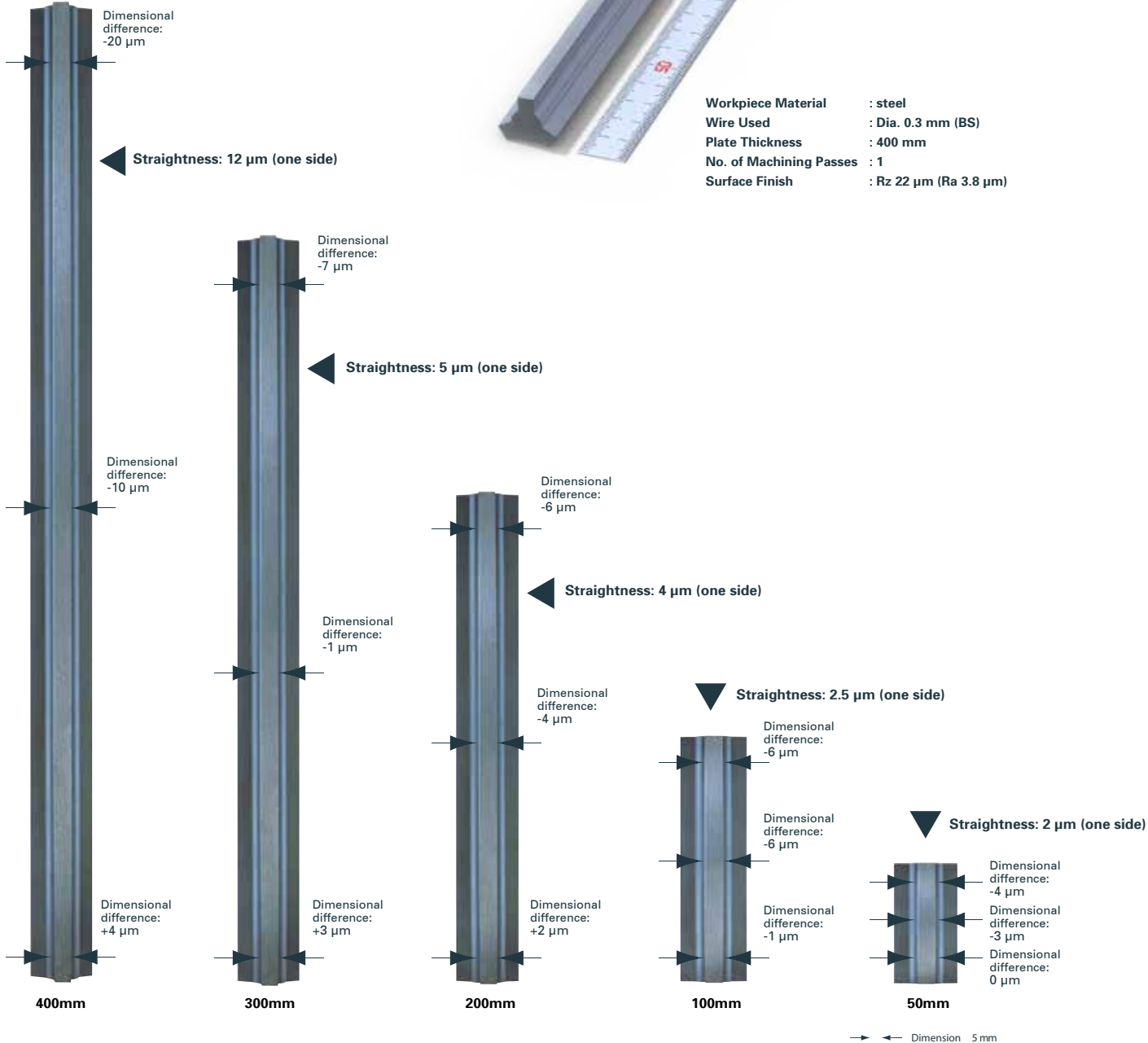

ProTech (OPTIONAL)

ProTech Technology is a proprietary enhancement to the U series that protect the work piece against rust. No need for harmful additives that may affect resin life as well as unpleasant side effects.

Benefits are effective on several kinds of materials such as steel, carbide, and aluminum.

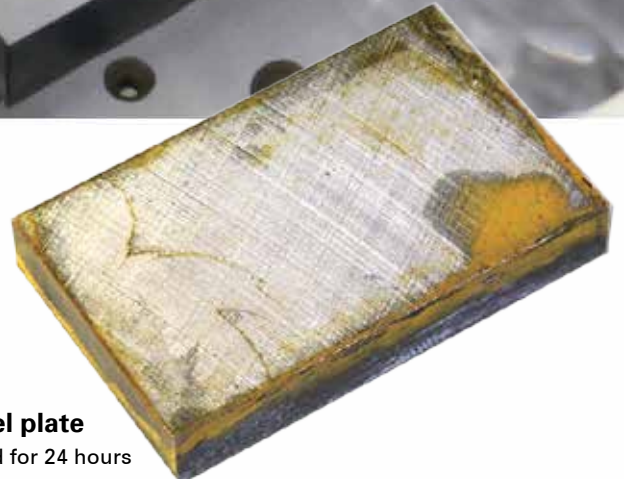
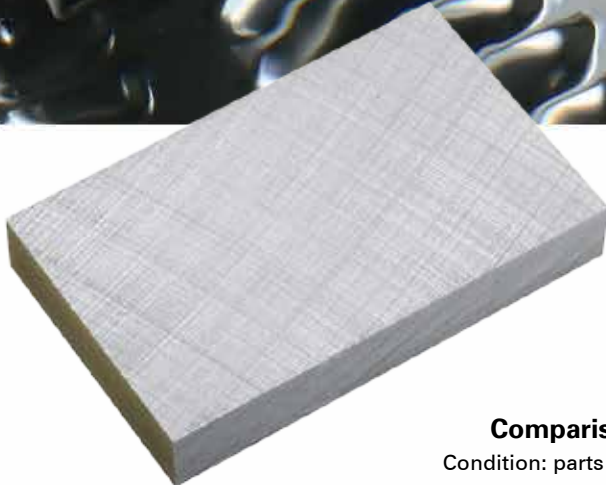

Comparison of a Steel plate

Condition: parts are submerged for 24 hours
Water conductivity: 15 $\mu\text{S} / \text{cm}$
Material: Steel S55C

With ProTech

Without ProTech

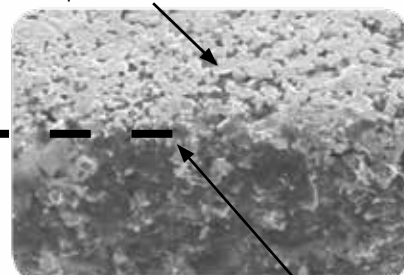
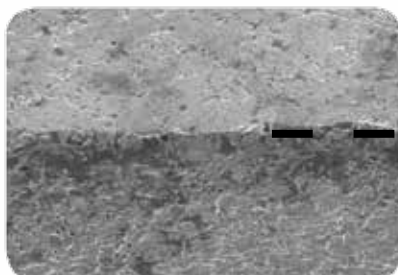

Undressed tungsten carbide particle

No fine edge

Comparison of a Tungsten Carbide

Condition: parts are submerged for 24 hours
Water conductivity: 15 $\mu\text{S} / \text{cm}$

LOW WIRE CONSUMPTION

Cut Fast, Cut Accurate, and Save Money!

The biggest expense in operating a Wire EDM machine is the consumed wire, and Makino has been the industry leader in low wire consumption technologies. There are no special settings or "part-time" buttons an operator has to enable to save on wire costs; every cutting condition, including sealed and poor flush applications, is automatically optimized and designed from the ground-up on the Makino for low wire consumption. Optimum machining performance is the ideal mix of machining speed, part accuracy, and wire consumption for the best combined efficiency, throughput, and cost. Only Makino can provide all 3 for every condition and application!



Up to 60% savings in wire costs

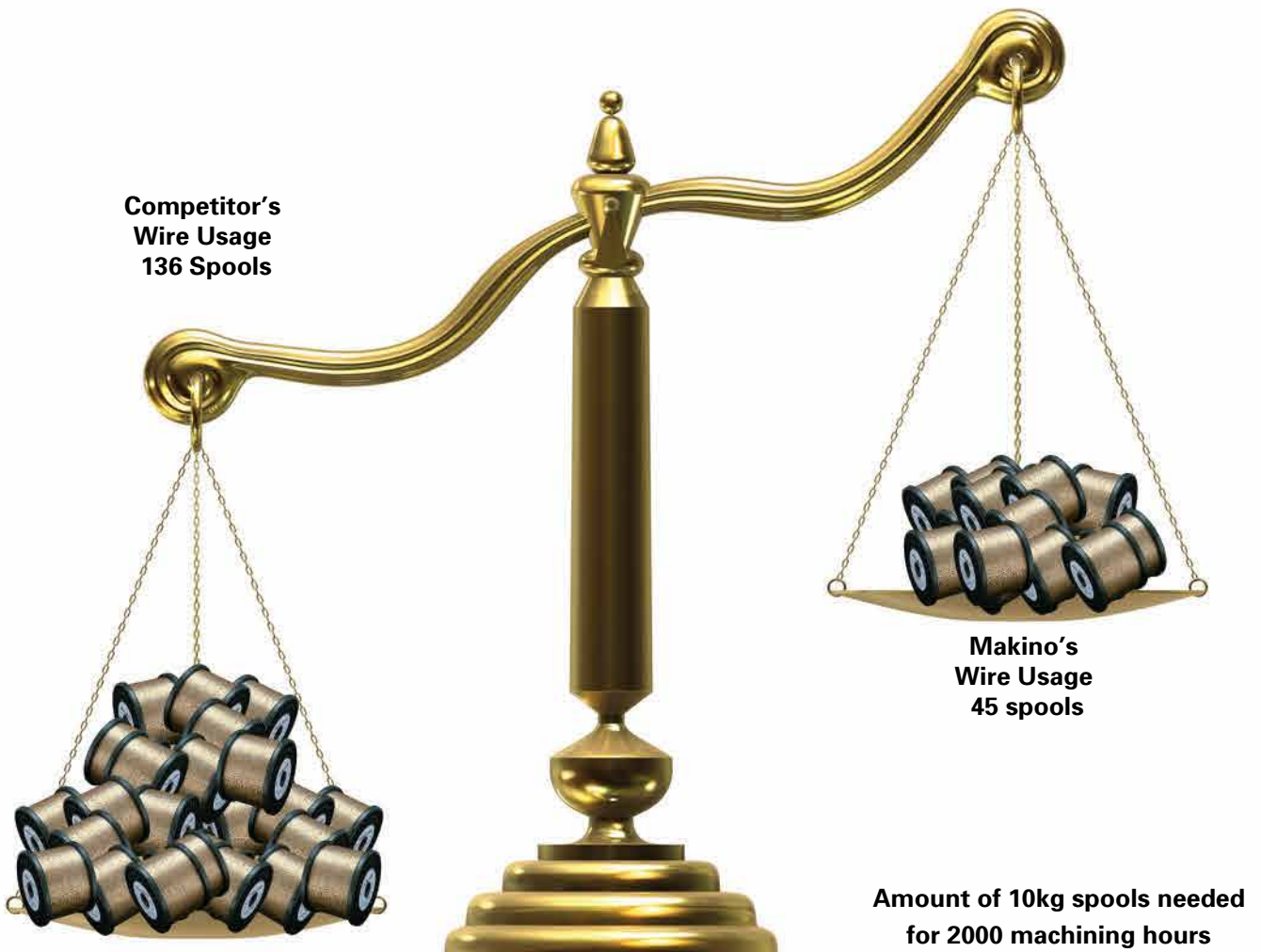

DUAL GUIDE OPTION



PICO Precision Guide system

Wire diameter: Dia. 0.1, 0.15, 0.2, 0.25, 0.3 mm

Pico Precision Guide System offers an innovative approach to closed round guides with high precision. Our Pico guides are specifically designed to cut Micro tapers with the highest possible accuracies. Initial start holes as low as 0.3mm are automatically threaded without failure. These guides also are able to successfully thread small holes located in very tight pitch locations.



Automatic wire threading through 0.4mm diameter start holes in close proximity at a 1mm pitch.

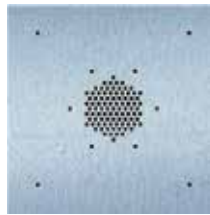

Star Holes Before Machining

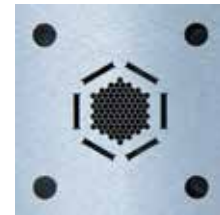

After Machining

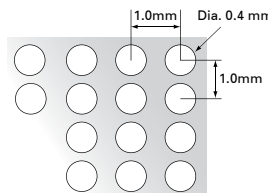

The wire is thread automatically through 0.4mm diameter start holes in close proximity at a 1mm pitch. The optimum fluid jet diameter can be selected to match the workpiece thickness and start hole diameter. Fluid jets are easy to replace and available in diameters of 0.5, 0.7 and 1.2mm

TWIN JET SYSTEM

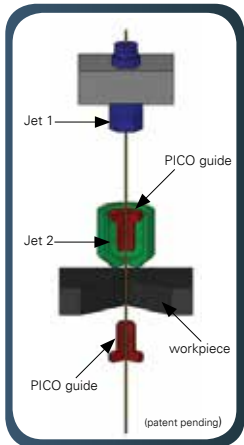

High performance twin-jet automatic wire threading system

Pico Precision Guides use a unique twin-jet system that can form a small diameter jet to assure pin point accuracy for reliable Automatic Wire Threading. The additional feature of our pecking system add further assurance of successful unattended operation. The design of the Guide Assembly allows quick exchanging of the wire guide diameter without the need to square or vertically align the wire.

Thermal Cutter System

The new wire cutting system will cut the wire without burrs and with pointed tip which further enhances the reliability of Automatic Wire Threading. It works on all range of wire.

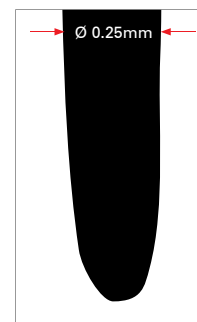

Wire Tip after Thermal Cutter

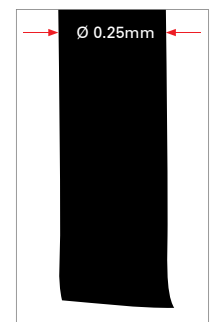

Wire Tip after Normal Cutter

Micro taper machining

The PICO guide system facilitates high-accuracy machining of micro tapers. This new guide system, combined with precise servo control, produces uniform machining along the entire length of the cut detail.



Workpiece Material: S55C (tool steel)
 Wire Used: Dia. 0.2mm Hard Brass
 Process: 3 Pass Machining
 Operation: 4-Axis Machining of Trim Die
 Geometry: 2.0mm Straight Land with
 1° Back Taper Relief over
 3D Contour

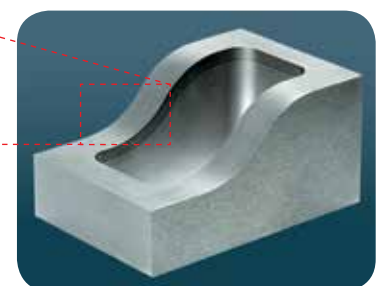



Split Precision Guide System

Wire diameter: Dia. 0.1, 0.15, 0.2, 0.25, 0.3 mm

Split Precision Guides use two separate PCD components mounted to ceramics. The Split Precision guides open during threading cycles, assuring AWT reliability at any height. This low maintenance system also reduces operator intervention, and provides extremely long guide life. Split Precision guides are offered in V-Flat and C-Type configurations. The Split Precision V-guide system is perfect for high production applications, while the Split Precision C-Guides are the best solution for high taper angle machining.



Common to Split Precision and PICO

High Speed AWT to 10 seconds

The optimal threading cycle can be selected according to the process or application, such as hole diameter size, plate thickness, or wire type used. These threading options will increase the reliability and speed cycle of the Auto Wire Threading process, and are vital in supporting the reliable wire threading of special high-speed coated wires.

AWT up to 400mm-thick workpiece

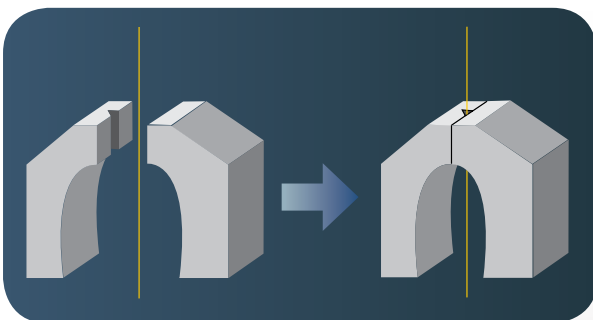

Split Precision guides perform reliable threading cycles in thick work pieces as a result of a larger target area while the guides are open.

Makino Pre-Guide Technology

In order to maintain the wire straightness, Makino's Wire guide system has an additional Sapphire guide positioned between the wire guide and the energizer plate. This assures proper contact of the wire to the energizer as the energizer wears.

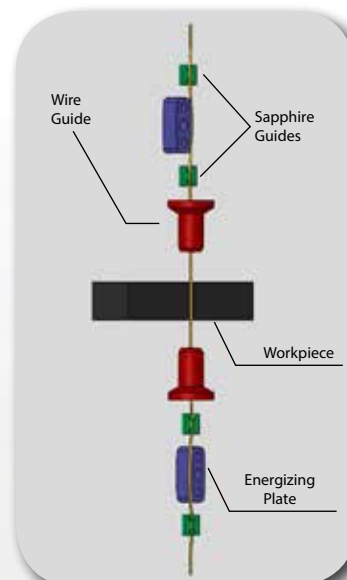

MAINTENANCE

Filter change is a breeze

The main di-electric filters are conveniently located in a non-submerged cabinet that allows for fast and simple replacement. To make filter replacement easier and safer, an integrated Filter Air Purge system is used to drain excess water from the filters. Operators will find this feature extremely helpful as it will make handling the filters much less weight intensive, and it also minimizes the water and slip hazards on the floor that are common during filter replacement. 4 Filter System are standard in case of H.E.A.T. configuration.

Air is blown by pressing the button and evacuates water captured inside the filter.



Maintenance of the Energizing Plate

The Energizer Plates are easily accessed on the Upper and Lower machine heads, and the design minimizes maintenance requirements. The PICO Guide system features a tool-less Energizer Indexing system that simplifies index positioning with on one rotation / "one-click" design that saves time and eliminates error or the need for cumbersome measuring devices.

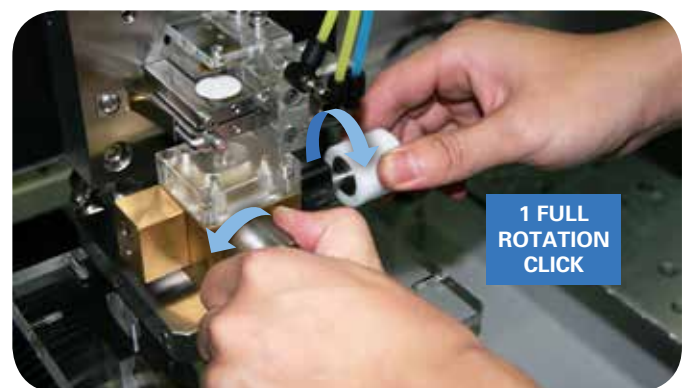
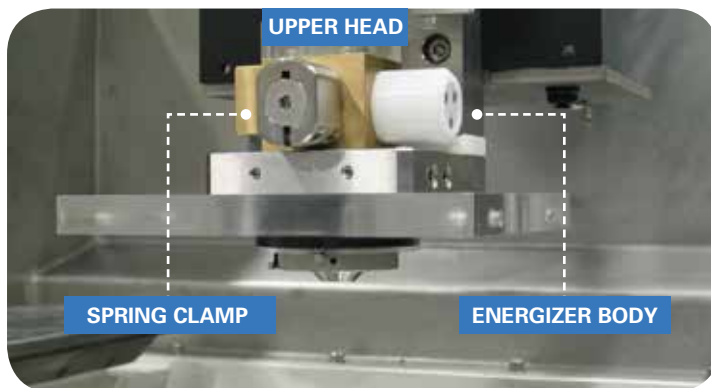

Guide Cleaning

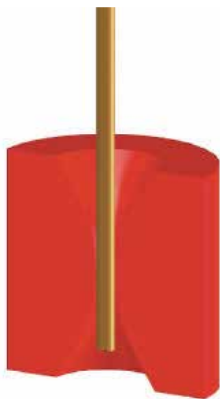

After sludge Removal



Removal of sludge

As a result of our Pico Guide being a closed round system, sludge can become an issue for maintenance. Makino has developed a special twin jet system that aids in the continuous removal of sludge each and every time a thread occurs. This design extends the guide maintenance interval, and provides greater machine reliability.



Consumable monitoring by Hyper-i

Dedicated Maintenance screens provide the operator with convenient access to consumable item status, part descriptions, and maintenance procedures. Hyperlinks to the on-board digital manuals and embedded videos provide enhanced training and support to the operator for machine maintenance.

The screenshot shows a software interface for machine maintenance. On the left, there are several gauges for 'MATCHING SPEED' (0.0000), 'CONVECTIVITY' (250.0), 'FLUID UPPER' (0.5 MPa), 'FLUID LOWER' (0.5 MPa), and 'FILTER' (0.5 MPa). The main area is a table with columns for 'No.', 'Check Item', 'Status', 'Check Day', 'Next Check Day', and 'Comment'. The table lists 9 items, with the first 7 marked as 'Check' and the last two as 'Uncheck'. At the bottom, there are buttons for 'Preparation', 'Program', 'Setup', 'Run', 'Record', 'Maintenance', 'Option', and 'ITEM Assist'.

No.	Check Item	Status	Check Day	Next Check Day	Comment
1	Swiveling clutch roller (D-shaft)	Check	9/2/2013	10/2/2013	last repl: Sep2013
2	Adjusting tension of powder duct	Check	9/2/2013	10/2/2013	
3	Cleaning a die of wire guide unit (upper)	Check	9/2/2013	10/2/2013	
4	Cleaning the upper round guide	Check	9/2/2013	10/2/2013	last repl: Aug2013
5	Wire vertical alignment	Check	9/2/2013	10/2/2013	U+2um Y: 3um
6	Cleaning inside of clean tank and dirty tank	Check	9/2/2013	10/2/2013	OP 105 in charge
7	Cleaning the Float Switches & Level Sensor Port	Check	9/2/2013	10/2/2013	
8	User Check 5	Uncheck			
9	User Check 6	Uncheck			



Makino's Split Guide system is the ultimate solution in decreased maintenance as a result of the open architecture design. At the touch of a button or wire threading cycle the guides open for ease of maintenance.



EASY OPERATION



Load workpiece with crane

The machine head can be moved to provide minimal obstructions when loading a large work piece by overhead crane.



Accessibility

The automated front Drop Door design allows easy loading / unloading of large work piece's on the table. The drop door also travels below the work table level, allowing for excellent access underneath the work table for maintenance and machine operation purposes. Additionally, operators can use mechanical work holding lifters directly in front of the machine.



Intermediate Door

A unique door system (only available on the U6 and U6 H.E.A.T.) allows door operation to an intermediate level for convenient viewing and access to the workpiece.

Portable multifunction control panel

Makino provides "as standard" a multi-function Handbox with digital readout. This advanced and portable hand box offers a wide range of features that provide operators with convenient and time-saving functions during set up and operation of the machine.



Wire disposal box with wheels

The need for a Wire Chopping Unit is eliminated as a result of Makino's unique Wire Cleaning and Wire Drying system. The wire coils up neatly and cleanly in the wire collection bin as a result of being completely dry before passing through the pinch rollers, and this design reduces maintenance requirements while boosting machine reliability. The large capacity wire collection bin allows easy removal of spent wire, and is mounted on wheels for effortless movement.

EASY OPERATION

Long-Life Pinch Rollers

The design of Makino's Wire Retrieval System reduces maintenance requirements while extending the life of consumable wear items. The wire is cleaned and then dried before passing through the precision ceramic rollers. This eliminates the introduction of abrasive debris and water to the roller and bearing system, and prevents wire slippage across the rollers. The design provides reliable operation that delivers clean spent wire that lays flat in the wire basket. The combined system eliminates the needs for a wire chopper, making it the most reliable, longest lasting and trouble free Wire Retrieval system in the industry!



Productivity Enhancing Options

3D Setup Probe System

An available 3D Probe System helps boost productivity by further reducing setup time. The system utilizes a high accuracy Renishaw probe that can establish work piece locations and 3D Leveling of the work piece. The 3D Probe system can also be configured to support setup of NC Rotary Table applications for cutting tool manufacturing

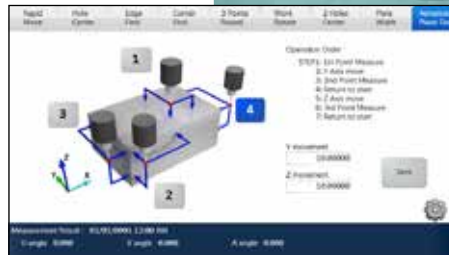
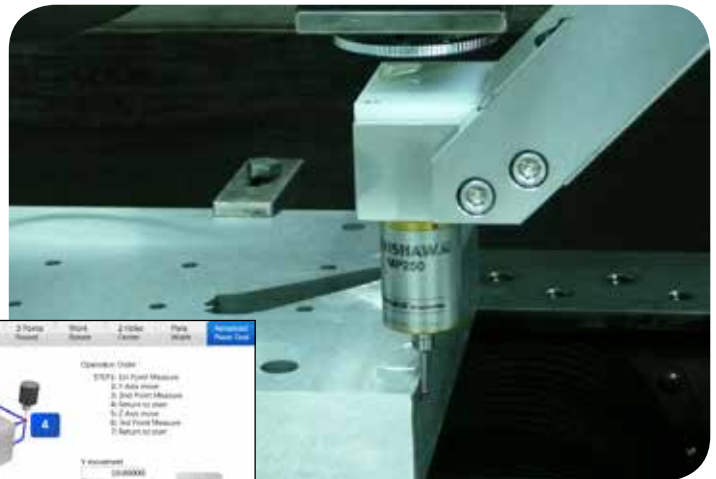

Large Capacity Wire Spool

The standard machine configuration accepts up to a 10kg wire spool. To extend unattended machine capability, there are two large spool options available. The 16kg wire spool option upgrades the standard machine configuration to accommodate larger capacity spools on the existing wire drive system. The 20kg wire spool option adds an external cabinet to the left-side of the machine that provides higher capacity with a more ergonomic and operator friendly system for utilizing heavier wire spools.



WIZ CAD/CAM (option)

The WIZ CAD/CAM software is a dedicated programming system for Makino Wire EDM machines. It is available as an off-line PC version or can be integrated on the machines Hyper-i control.

The WIZ software incorporates all of the machines cutting conditions libraries and special functions of the Hyper i control, streamlining the programming process. Importing and Exporting of CAD information makes for convenient data transfer, and the WIZ software is capable of editing or creating new CAD geometry.

The WIZ software also features a full simulation function that verifies the created program, and this helps to improve machine utilization by minimizing setup or dry run operations. 2D, Taper, and 4-Axis Machining are supported by the WIZ software, and additional modules are available for importing of specialty CAD files, and direct programming for rotary table applications

2nd Display Screen (option)

A 2nd 24" HD display touch screen for the Hyper-i control is available to aid in operator convenience. The 2nd screen is commonly used when integrating the WIZ software on the machine, as this allows the operator to still monitor the machine screens while preparing and programming the next job.

The Hyper i control also further supports the dual display configuration to boost multi-tasking. Operators have the ability to change and configure what machine screen or data is displayed on the 2nd screen, which allows customization and placement of data where it is needed.

EDM Mail (option)

Provides the ability for the machine to send automatic email messages that alert to machining progress or alarm states.

EDM Viewer (option)

Enables the operator to access the machine control from a remote PC to view machining status, or to verify and create new machine programs.

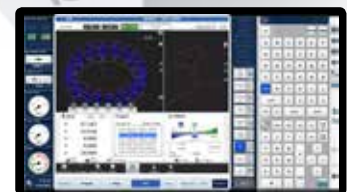
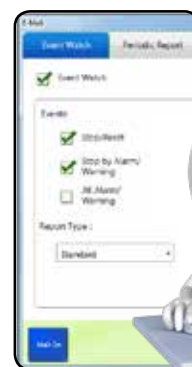
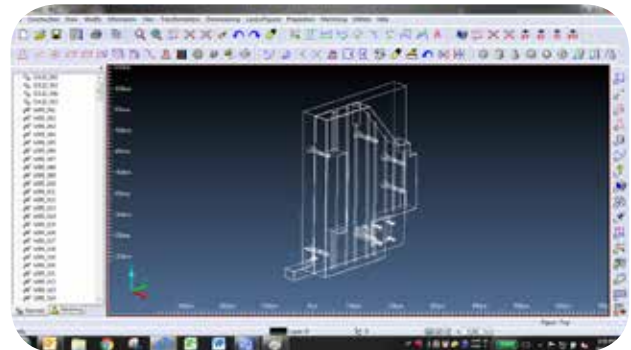

Machine Specifications

		U3 / U3 H.E.A.T.	U6 / U6 H.E.A.T.
Travels (X x Y x Z axes)	mm	370 x 270 x 220	650 x 450 x 420
Travels (U x V axes)	mm	±50 x ±50	±75 x ±75
Table Working Area	mm	630 x 460	910 x 710
Maximum Workpiece size	mm	770 x 590 x 220	1000 x 800 x 400
Maximum Dielectric Fluid Height	mm	260	455
Maximum Workpiece Weight	kg	600	1500
Height of Table Surface mm		950	1000
Wire Electrode Diameter	mm	Dia. 0.1, 0.15, 0.2, 0.25, 0.3	Dia. 0.1, 0.15, 0.2, 0.25, 0.3
Maximum Taper Angle		±15° / 100mm *1	±15° / 100mm *1
Dielectric Fluid Tank Capacity	L	670	1000
Deionizing Resin		20-liter pack	20-liter pack
Dielectric Fluid Filters		2 / 4	2 / 4
Machine Dimensions (W x D)	mm	1981 x 2523	2229 x 3151
Machine Height (h)	mm	2116	2350 / 2350 *2
Floor Space (W x D)	mm	2580 x 3650	2700 x 4310
Machine Weight	kg	3200 / 3300	5200 / 5300

*1 In the case of PICO precision guide system, MEGACUT-A wire is required for taper machining larger than 10°. And Machinable taper angle larger than 2° is limited according to jet nozzle diameter.

*2 When opening filter case door, Machine height is 2440 mm.

EW100A Power Supply Unit

Item	Specification
Circuit Type	Transistor Pulse Circuit
Maximum Machining Current	30 A
Current Settings	128 levels
Voltage Settings	35 levels
Off Intervals	256 levels
Automatic Voltage Regulator	Standard
Cooling System	Forced Air Cooling
LL Generator Circuit	Standard

Jet nozzle diameter and start hole diameter (for machining with nozzle contact) (*2)

Work Thickness (mm)	Start Hole Diameter (mm)											
	0.4	0.5	0.6	0.7	0.8	0.9	1.0	1.1	1.2	1.3		
0 - 30												
0 - 50												
0 - 100												

Dia Ø0.5mm jet
 Dia Ø0.7mm jet
 Dia Ø1.2mm jet

Standard Specifications

- H.E.A.T. (Only for U3 H.E.A.T and U6 H.E.A.T)
- Submerged Machining Specifications
- PICO Precision Guide System
- U Shape Work Table
- Automatic Water Level Setting
- Automatic Wire Threading Unit
- Fine-hole Automatic Wire Threading Unit
- Jet Nozzle (Dia ø 1.2mm)
- Dielectric Fluid Cooling Unit
- Automatic Power Failure Recovery
- Power Supply Line Filter
- Portable Multifunction Control Panel FPB2
- Ethernet 10/100BASE-TX
- USB Flash Memory Interface
- Program Storage 40GB
- Dielectric filter air purge
- Wire box with wheels
- CNC Controller - Hyper I
- Large Full HD Multi-touch screen
- EDM Explorer
- Network connection - Ethernet 1000 BASE-T / 100 BASE-TX / 10 BASE-T

Optional Specifications

- Machine**
- Square Shape Work Table
 - Special Hardening Work Table (U Shape, Square Shape)
 - 0.05 µm Scale Feedback (X,Y axes or X,Y,U,V axes)
 - Special Customer-specified Machine Colors
 - Split Precision guide system

Optional Equipment

- Machine**
- ◆ Large Capacity Wire Spool (16 kg)
 - ◆ Large capacity Wire Spool Loader (20 kg or 30 kg)
 - ◆ Jet Nozzle (Dia ø 0.5, 0.7 mm) only for PICO
 - ◆ Workpiece Clamp Set
 - ◆ Automatic Water Supply Unit
 - ◆ Workpiece Washing Gun
 - ◆ Maintenance Set
 - ◆ Running Kit
 - ◆ Work Light
 - ◆ ProTech
 - ◆ Keyboard and mouse
- Control System**
- ◆ EDM Viewer
 - ◆ EDM Mail
 - ◆ Alarm Signal Tower (1, 3 lamps)
 - ◆ Operated Circuit Breakers
 - ◆ Anti Virus

Machine Layout

UB | UB H.E.A.T.

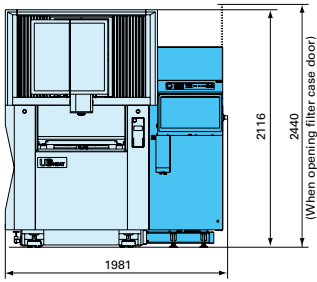

UB | UB H.E.A.T.

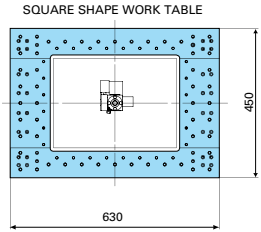

UB

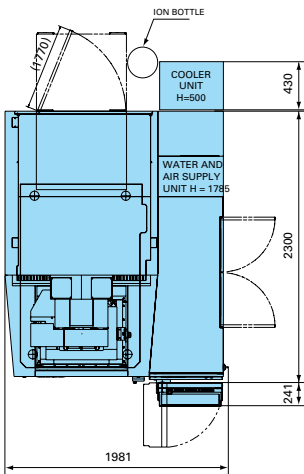

UB H.E.A.T.

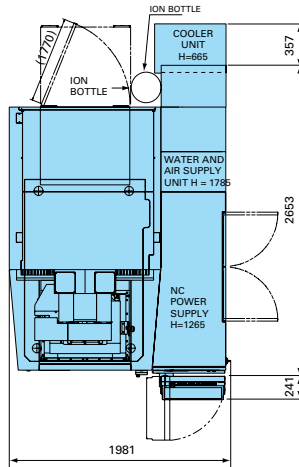

UB | UB H.E.A.T.

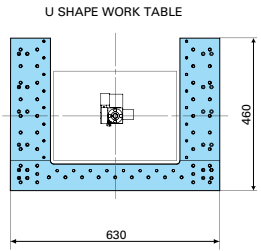

U6 | U6 H.E.A.T.

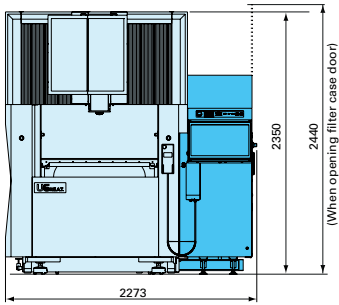

U6 | U6 H.E.A.T.

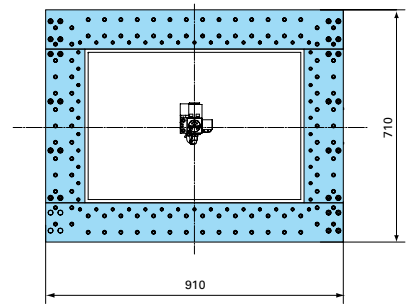

U6

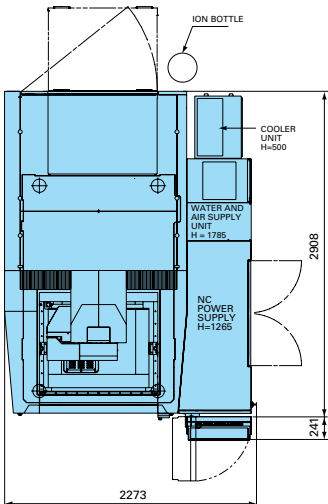

U6 H.E.A.T.

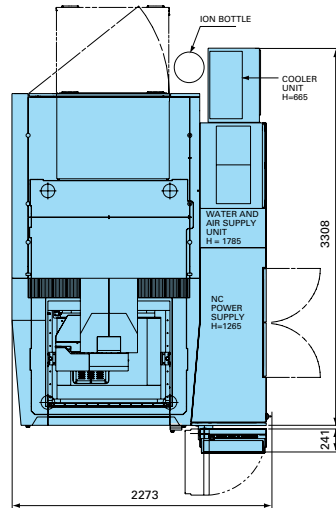

U6 | U6 H.E.A.T.

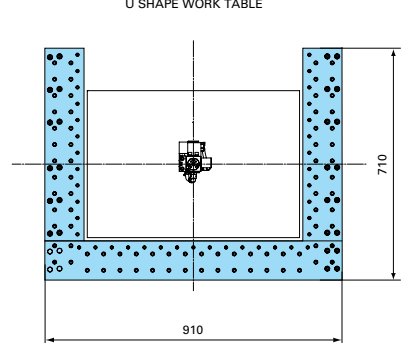



Makino, Inc.

7680 Innovation Way
Mason, Ohio 45040
513-573-7200

Makino Die/Mold & EDM Technology Center

2600 Superior Court
Auburn Hills, MI 48326
248-232-6200

Makino Canada

170 Ambassador Drive Unit #1
Mississauga, ON L5T 2H9
905-565-6886

Makino Mexico

Retorno El Marques #3
Parque Industrial El Marques
Querétaro, México CP 76240
442-253-1003

Makino Brazil

Rua Iracema Lucas, 450 (Antiga Rua Parsh), Distrito Industrial
CEP 13280-000,
Vinhedo, São Paulo, Brasil
55 19 3826-7373

Makino Milling Machine, Ltd.

Tokyo, Japan
81-3-3717-1151

Makino Asia Pte., Ltd.

Jurong Town, Singapore
65-861-5722

Makino GmbH

Hamburg, Germany
49-40-29809-0

This document and its contents are the property of Makino Inc. No disclosure, duplication, or use of any portion of this document or its contents for any purpose contrary to the interests of Makino Inc. may be made without prior written consent of Makino Inc.

Manufacturer's specifications are accurate as of the date of publication and may be changed without prior notice to incorporate improvements resulting from ongoing R&D programs.

Machines displayed in this catalog are fitted with optional equipment.

©Copyright 2016 Makino